

# Power Ball valves One-piece forged metal-seated

U.S. Patent# 6,095,493



**ASME CLASSES: 3100-4500**  
**Sizes: NPS ½-4 (DN 15-100)**

**VELAN**

## VELAN AT A GLANCE

### History

- Founded in 1950

### People

- Over 2,000 employees

### Product line

A world-leading range of valves across all major industrial applications:

- Cast steel gate, globe, check, and ball valves
- Forged steel gate, globe, check, and ball valves
- Triple-offset butterfly valves
- Knife gate valves
- Severe service valves
- Bellows seal valves
- Steam traps

### Primary industries served

- Fossil, nuclear, and cogeneration power
- Oil and gas
- Refining and petrochemicals
- Chemicals and pharmaceutical
- LNG and cryogenics
- Marine
- HVAC
- Mining
- Water and wastewater
- Pulp and paper
- Subsea

### Velan holds major applicable approvals:

- ASME Section III N and NPT for nuclear valves (since 1970)
- ISO 9001 (since 1991) and ISO 14001
- OHSAS 18001
- PED
- SIL
- GOST
- API 6A and API 6D
- TA-Luft
- Comprehensive quality programs that are compliant with the most stringent industry standards such as ISO 9001, API Q1, NCA 4000, ASME NQA-1 and 10 CFR 50 Appendix B.
- Velan has been surveyed and audited by leading organizations around the world such as Bureau Veritas, API, ASME, NUPIC, Newport News Shipbuilding, and DCMA.
- Total Process Improvement Program, including Lean Manufacturing and Six Sigma



Velan is one of the world's leading manufacturers of cast and forged steel gate, globe, check, ball, triple-offset, knife gate, highly engineered severe service valves, and steam traps offering superior performance across all major industrial applications including: fossil, nuclear, and cogeneration power; oil and gas; refining and petrochemicals; chemicals and pharmaceutical; LNG and cryogenics; marine; HVAC; mining; water and wastewater; pulp and paper; and subsea. The company also supplies actuators and integrated control packages.

Founded in 1950, Velan has earned a reputation for product excellence and innovation by bringing to the market superior products with special emphasis on quality, safety, ease of operation, and long service life. Velan valves have an extremely broad installation base and are approved by major companies worldwide.

Velan concentrates on one business—the design, manufacture and marketing of steel valves in a broad range of types and sizes for high performance service in a wide range of applications. The company's talented people are focused on Velan's core values of quality, reliability, innovation, and integrity and mission to be the world's leading valve brand.

## TABLE OF CONTENTS

Global network.....	2-3
Total quality and process improvement .....	4
Engineered solutions .....	5
Design features .....	6-7
Standard materials and parts .....	8
Standard dimensions and top works .....	9-10
End connection table .....	11
Pressure/temperature and torque value tables .....	12
Actuators .....	13
Mounting pad and stem head dimensions .....	13
Power Ball valve applications in service .....	14
Velan valves for the power industry .....	14-15
How to order .....	15



# VELAN'S GLOBAL NETWORK

## Head office



Montreal, Canada  
Velan Inc.

- 14 production facilities
- 4 plants in North America
- 5 plants in Europe
- 5 plants in Asia
- 4 stocking and distribution centers
- Hundreds of distributors worldwide
- Over 60 service shops worldwide

## Manufacturing plants

### North America



Montreal, Canada  
Velan Inc., Plant 1



Montreal, Canada  
Velan Inc., Plant 2 and 7



Granby, Canada  
Velan Inc., Plant 4 and 6



Williston, VT, U.S.A.  
Velan Valve Corp., Plant 3



### Europe



Lyon, France  
Velan S.A.S.



Mennecy, France  
Segault S.A.



Lisbon, Portugal  
Velan Válvulas Industriais, Lda.



Lucca, Italy  
Velan ABV S.r.l., Plant 1



Lucca, Italy  
Velan ABV S.r.l., Plant 2

### Asia



Ansan City, South Korea  
Velan Ltd., Plant 1



Ansan City, South Korea  
Velan Ltd., Plant 2



Taichung, Taiwan  
Velan Valvac Mfg. Co., Ltd.



Suzhou, China  
Velan Valve (Suzhou) Co., Ltd.



Coimbatore, India  
Velan Valves India Pvt. Ltd.

## Distribution centers



Granby, Canada  
VelCAN



Benicia, CA, U.S.A.  
VelCAL



Missouri City, TX, U.S.A.  
VelTEX



Willich, Germany  
Velan GmbH

 – ASME N-stamp accredited manufacturer

# TOTAL QUALITY AND PROCESS IMPROVEMENT



## ▼ Total Quality Commitment ▼

Velan Total Quality Program

*Our aim is to offer products and services that not only meet but clearly exceed the expectations of our customers.*

*Through training, teamwork, and performance, our employees strive to achieve continuous improvement of all processes.*

*Our goal is Total Quality and On-Time Delivery; our method is Total Commitment.*

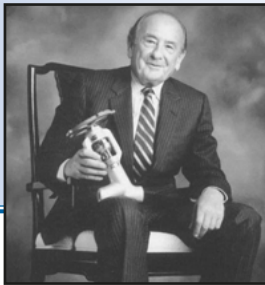

*A.K. Velan*

**A.K. Velan,  
Founder of Velan**

Velan's number-one priority is quality. From order entry to design engineering to the shop floor, the entire company is totally committed to offering products and services that not only meet but exceed customer expectations. All Velan valves are designed and manufactured with an emphasis on low emissions, safety, simple maintenance, ease of operation, and, above all, long and reliable service life.

## TOTAL PROCESS IMPROVEMENT

While Velan has always made quality a priority, in 1990 the company adopted a formal Total Quality Management Program, aimed at improving production processes and was awarded ISO 9001 status the following year.

Today, Velan's Total Process Improvement Program brings together a group of industry best practices, including Lean Manufacturing and Six-Sigma, with the goal of creating a more balanced and efficient production system.

## TOTAL PROCESS IMPROVEMENT PROGRAM

- Total Quality Management Program (since 1990)
- Lean Manufacturing
- Six-Sigma

## CERTIFICATIONS/APPROVALS

- ASME N/NPT (since 1970)
- ISO 9001 (since 1991)
- ISO 14001
- OHSAS 18001
- PED
- API
- SIL
- TA-Luft

## CERTIFICATES/APPROVALS

Velan holds major applicable approvals, including ASME N/NPT, ISO 9001, ISO 14001, OHSAS 18001, PED, API, SIL, TA-Luft, etc. Velan designs and manufactures valves in accordance with ASME B16.34 and other recognized International standards such as API and ASME Sec. III; we implement comprehensive quality programs that are compliant with the most stringent industry standards such as ISO 9001, API Q1, NCA 4000, ASME NQA-1 and 10 CFR 50 Appendix B.

Velan has been surveyed and audited by leading organizations around the world such as Bureau Veritas, API, ASME, NUPIC, Newport News Shipbuilding, and DCMA.





# ENGINEERED SOLUTIONS

Velan's Engineering Design and Applications Group comprises approximately 50 professional engineers with extensive experience in critical applications across a broad range of industries. Equipped with advanced software applications, including finite element analysis (FEA), computational fluid dynamics (CFD), and 3D solid modeling, Velan engineers design superior quality valves that meet the most demanding performance requirements. Velan's R&D facilities, equipped with steam boilers and superheaters, flow loops, and cryogenic test stands, provide the company with extensive testing capabilities.

Whether we are refining the design of our standard valves or engineering valves to meet the demands of a specific application, Velan's vast engineering resources can handle the task. In fact, Velan has a long history of partnering with major architect/engineers, electric utilities, and other end users to develop innovative solutions for their valving needs.

Velan's production machinery and equipment are specially engineered to meet the requirements of advanced large valve manufacturing. This includes large CNC horizontal and vertical boring mills with tool changers, CNC lathes, and CNC machining centers. Over 150 CNC machines are in operation in Velan's North American plants. All welding techniques employed at Velan are in accordance with qualified welding procedures for SMAW, GTAW, GMAW, PTAW, and SAW processes.

Production testing equipment is designed to safely and efficiently test high-pressure valves in strict accordance with industry codes and standards, as well as customer-imposed criteria.

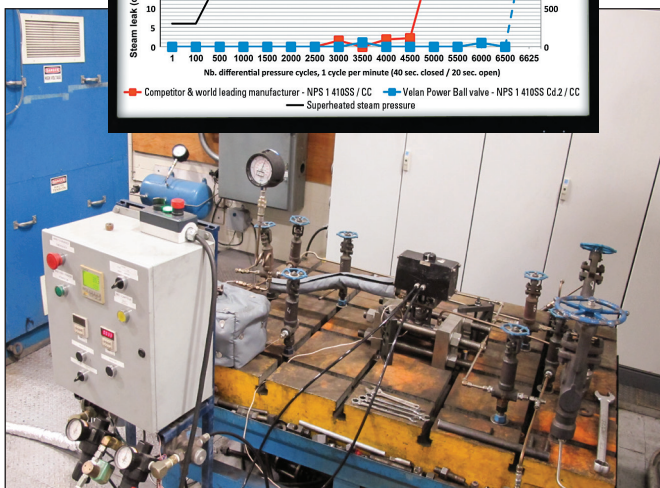
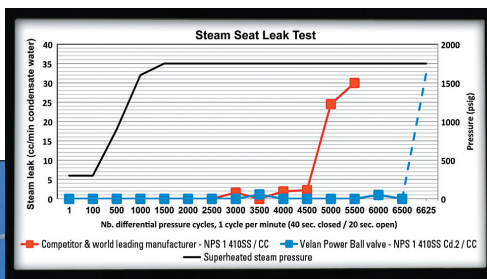

Superheated steam endurance test in progress (900°F - 1,750 psig / 482°C - 121 bar). 150 cold and 7000 thermal cycles with 900°F (482°C) superheated steam and "0" leakage after 6,500 cycles.

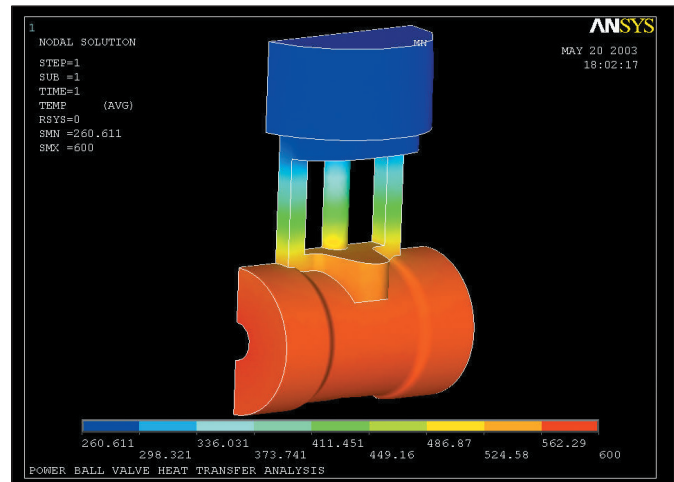

Power Ball valve heat transfer analysis.

In addition, we are engaged in advanced research in coating technology, using the services of independent laboratories for abrasion, sliding wear, bond strength testing, scanning electron microscopy, and x-ray diffraction.

Velan's QA system is geared towards continuous improvement, process quality, and stringent compliance to worldwide quality standards (e.g., ASME Section III, PED, TUV, ISO 9001:2008). Automated honing, mate-lapping, and vacuum testing of all metal-seated ball valves is an integral part of Velan's quality process.

Advanced tooling design and optimized industrial engineering concepts, combined with state-of-the-art manufacturing plants employing over 165 CNC machining centers, enable us to produce high-quality products at competitive costs for our valued customers.

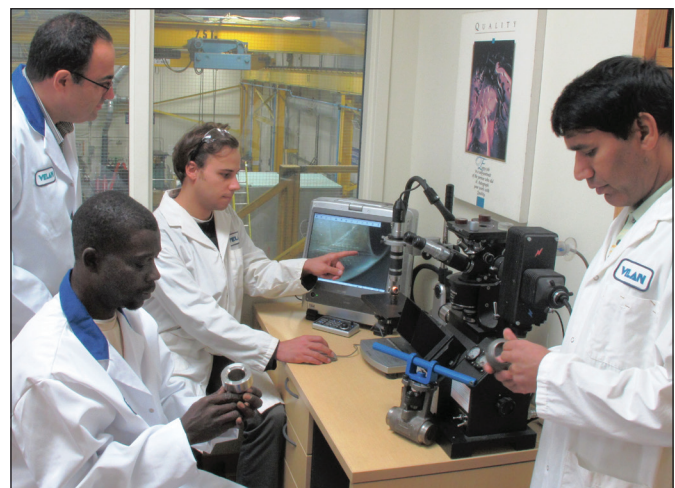

Members of Velan's R&D team examine a Power Ball valve under an optical microscope after an endurance cycle test.

# SUPERIOR DESIGN AND UNIQUE CONSTRUCTION

Velan's Power Ball valve is a highly advanced, patented, forged, one-piece metal-seated valve designed for high-pressure/high-temperature applications in the power generation and process industries.

**Socket weld**  
NPS ½–2½ (DN 15–65)

**VALVE IN OPEN POSITION**

**Butt weld**  
NPS ½–4 (DN 15–100)

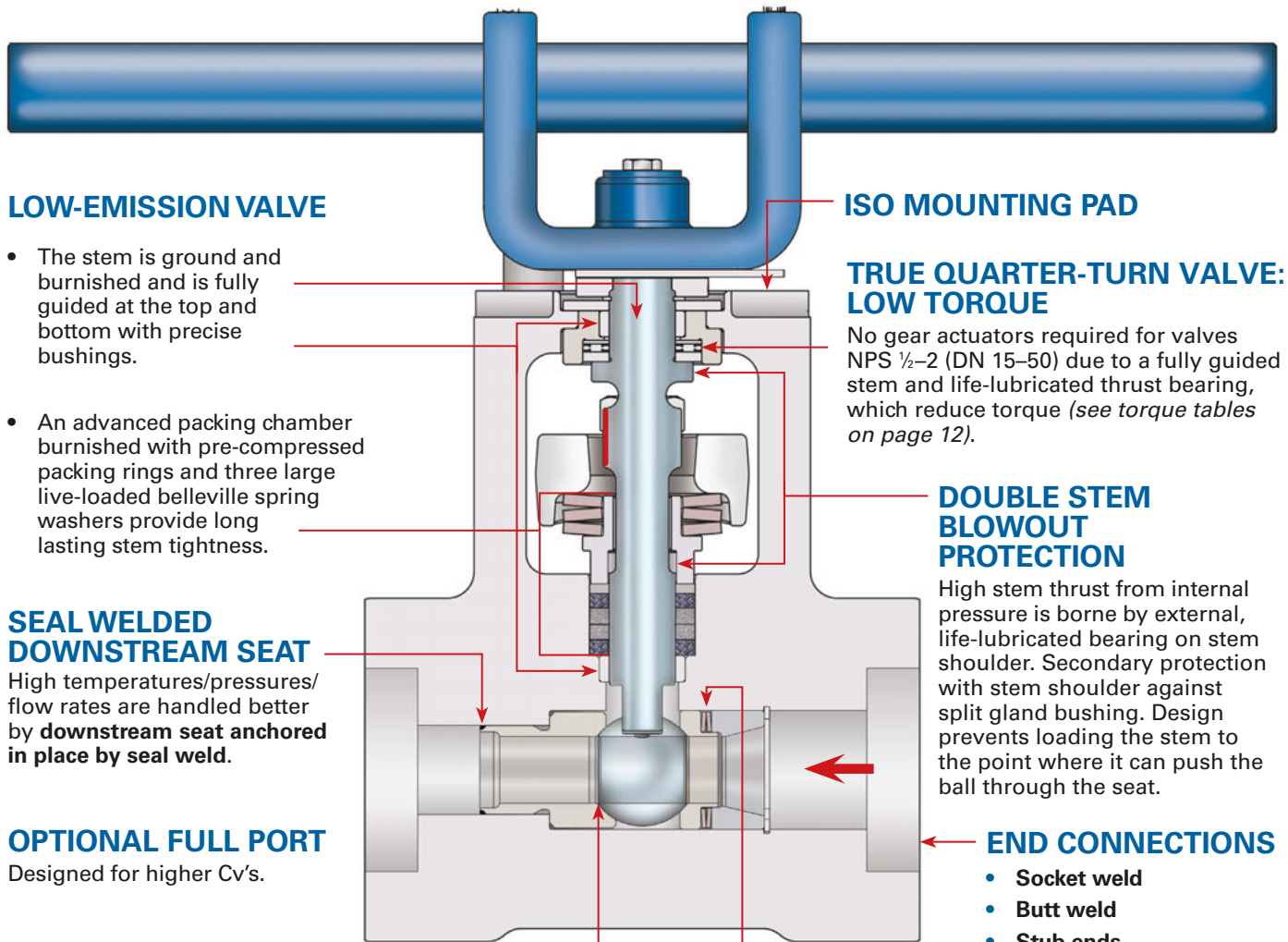

## LOW-EMISSION VALVE

- The stem is ground and burnished and is fully guided at the top and bottom with precise bushings.
- An advanced packing chamber burnished with pre-compressed packing rings and three large live-loaded bellville spring washers provide long lasting stem tightness.

## SEAL WELDED DOWNSTREAM SEAT

High temperatures/pressures/flow rates are handled better by **downstream seat anchored in place by seal weld**.

## OPTIONAL FULL PORT

Designed for higher Cv's.

## "0" LEAKAGE SEALING INTEGRITY

- **Improved wider seat faces design** increase cycle life, reliability, and tightness longevity.
- **New spray and fused coating technology** for high-temperature applications up to 1250°F (677°C) as well as enhanced chrome carbide coating for temperatures not exceeding 1000°F (538°C).
- **The ball and seat are mate-lapped** to perfection, ensuring resistance to wear and galling and so providing long service life. Each valve is subjected to **low pressure air seat leakage testing** in accordance with MSS-SP-61 and FCI 70-2. Velan imposes a **zero leakage criterion**.

## ISO MOUNTING PAD

## TRUE QUARTER-TURN VALVE: LOW TORQUE

No gear actuators required for valves NPS ½–2 (DN 15–50) due to a fully guided stem and life-lubricated thrust bearing, which reduce torque (see torque tables on page 12).

## DOUBLE STEM BLOWOUT PROTECTION

High stem thrust from internal pressure is borne by external, life-lubricated bearing on stem shoulder. Secondary protection with stem shoulder against split gland bushing. Design prevents loading the stem to the point where it can push the ball through the seat.

## END CONNECTIONS

- Socket weld
- Butt weld
- Stub ends
- Flanged
- NPT
- Blank

## INCONEL 718 LOADING RINGS

Maintains tight contact between seats and ball, protecting seats in an open and closed position. Accommodates high-temperature transients, allowing thermal expansion.

# ASSURES RELIABILITY AND LONG SERVICE LIFE

**Velan's Power Ball valve joins a long list of proven products for power, including our forged bolted bonnet and pressure seal valves, bonnetless y-pattern globe valves, cast steel valves, small forged valves, large metal-seated ball valves, and bimetallic steam traps.**

**ASME class 3100-4500**

**VALVE IN CLOSED POSITION**

**U.S. Patent # 6,095,493**

## ONE-PIECE FORGED BODY WITH INTEGRAL ISO MOUNTING PAD FOR AUTOMATION

Rugged/durable, one-piece, forged body design eliminates the potential leakage of body/bonnet joint. Add to that Velan's unparalleled performance in stem-packing chamber sealing, and you have a recipe for trouble-free service in your plant.

The unique one-piece forged body construction of the Power Ball valve includes an integral mounting pad for automation.

Both the mounting pad and valve stem dimensions meet ISO-5211 standards, which allow for the direct-mount of actuators without the need for additional brackets and/or drive couplings. In addition to significant cost savings, a direct-drive actuator ensures the best possible alignment between the ball and operator.

For high temperature service, Velan can supply a heat gasket, placed between the valve and actuator, and/or actuators with high temperature trim, to protect the operator from heat transferred through the valve.

## NEW SLIDE HANDLE

- **New slide handle** that can be repositioned from its standard T-position left or right.
- **Mechanical stop** ensures proper ball orientation in closed and open position.
- **Stem and packing gland marking** is helpful in aligning actuators for closed position.

## VELAN POWER-COMBO FOR VENTS AND DRAINS

### Y-pattern and Power Ball valve combination

Capitalizing on the proven design features and superior performance of our Power Ball and y-pattern globe valves, Velan introduces an innovative POWER-COMBO, matching the forged Power Ball with our forged, one-piece y-pattern (as the flow on/off valve) for vent and drain service in high pressure/temperature systems. This combination provides for a higher measure of system integrity assurance, while extending the service life of the valves in this tough application. It can also be pre-fabricated at the factory or at our authorized repair facilities (simply provide pipe material, schedule, and applicable dimensions at time of request for quotation), or at the site by the end user.

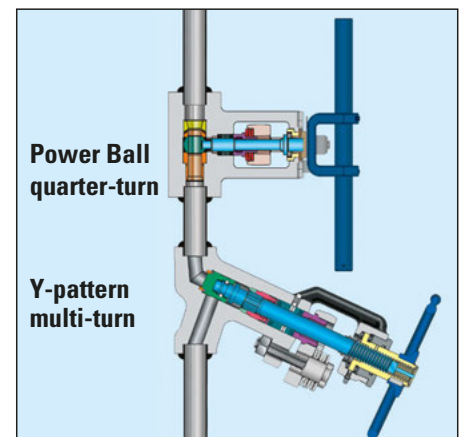

*Velan power-combo.*



# STANDARD MATERIALS AND PARTS

PART	STANDARD MATERIALS FOR CLASS 3100
Body	A105, A182 F22 Cl. 3, A182 F91, A182 F316
Stem	A479 Gr. 410 Cond. 2 <sup>(1)</sup>
Ball	A479 Gr. 410 Cond. 2, Chrome Carbide coated <sup>(2)</sup>
Downstream seat	A479 Gr. 410 Cond. 2, Chrome Carbide coated <sup>(2)</sup>
Upstream seat	A479 Gr. 431, Nitrided
Stem bushing (upper)	A479 Gr. 410, Nitrided
Stem bushing (lower)	A479 Gr. 410, Nitrided
Packing flange	A182 F22 Cl. 3
Split gland bushing	ASTM A351 Gr. CF8M
Packing rings	Die formed flexible Graphite
Anti-extrusion rings	Braided Graphite (no Teflon)
Stud (packing flange)	A193 B7 <i>Option: A193 B16</i>
Nut (packing flange)	A194 2H <i>Option: A194 Gr.4</i>
Lock nut	SS 304 <i>Option: A194 Gr.8</i>
Retaining ring (internal)	A564 15-7 P.H.
Thrust bearing	CS SAE 1060-1090
Screws	Alloy steel commercial
Hex head cap screws	Stainless steel
Lock washer	Stainless steel
Flat washer	Stainless steel
Slide handle	CS A106
Handle yoke	CS A216
Lock device	CS A516 galvanized
Live-loading rings	H11/H13
Loading rings	B 670 Gr.718 P.H. Inconel
Stop pin	A574 Alloy steel
Split yoke bushing	A479 Gr. 410 Condition 2
Thrust washer	Alloy steel commercial
Retainer bushing	A479 Gr. 410 Condition 2
Retaining ring (external)	Alloy steel commercial
Butt weld nipple	A105, A182 F22 Cl. 3, A182 F91, A182 F316

(1) For F91 valves, stem in A638 Gr.660

(2) Also available in B637 Gr.718 spray and fuse. Standard for F91.

PART	STANDARD MATERIALS FOR CLASS 4500
Body	A105, A182 F22 Cl. 3, A182 F91, A182 F316
Stem	A638 Gr. 660
Ball	B637 Gr. 718 Spray and fuse
Downstream seat	B637 Gr. 718 Spray and fuse
Upstream seat	A479 Gr. 413, Nitrided
Stem bushing (upper)	A479 Gr. 410, Nitrided
Stem bushing (lower)	A479 Gr. 410, Nitrided
Packing flange	A182 F22 Cl. 3
Split gland bushing	ASTM A351 Gr. CF8M
Packing rings	Die formed flexible Graphite
Anti-extrusion rings	Braided Graphite (no Teflon)
Stud (packing flange)	A193 B7 <i>Option: A193 B16</i>
Nut (packing flange)	A194 2H <i>Option: A194 Gr. 4</i>
Lock nut	SS 304 <i>Option: A194 Gr. 8</i>
Retaining ring (internal)	A564 15-7 P.H.
Thrust bearing	CS SAE 1060-1090
Screws	Alloy steel commercial
Hex head cap screws	Stainless steel
Lock washer	Stainless steel
Flat washer	Stainless steel
Slide handle	CS A106
Handle yoke	CS A216
Lock device	CS A516 galvanized
Live-loading rings	H11/H13
Loading rings	B 670 Gr. 718 P.H.
Stop pin	A574 Alloy steel
Split yoke bushing	A479 Gr. 410 Condition 2
Thrust washer	Alloy steel commercial
Retainer bushing	A479 Gr. 410 Condition 2
Retaining ring (external)	Alloy steel commercial
Butt weld nipple	A182 F22 Cl. 3, A182 F9

## REMOVAL OF PARTS

- Valve parts can only be disassembled for service outside the line after removal from pipe. This ensures safety in high-pressure operation.
- The ball in closed position and the upstream seat must be removed first to allow removal of all other parts.
- The gland bushing and yoke bushing are split to facilitate disassembly.
- See Power Ball Valve Maintenance Manual (PBVM).

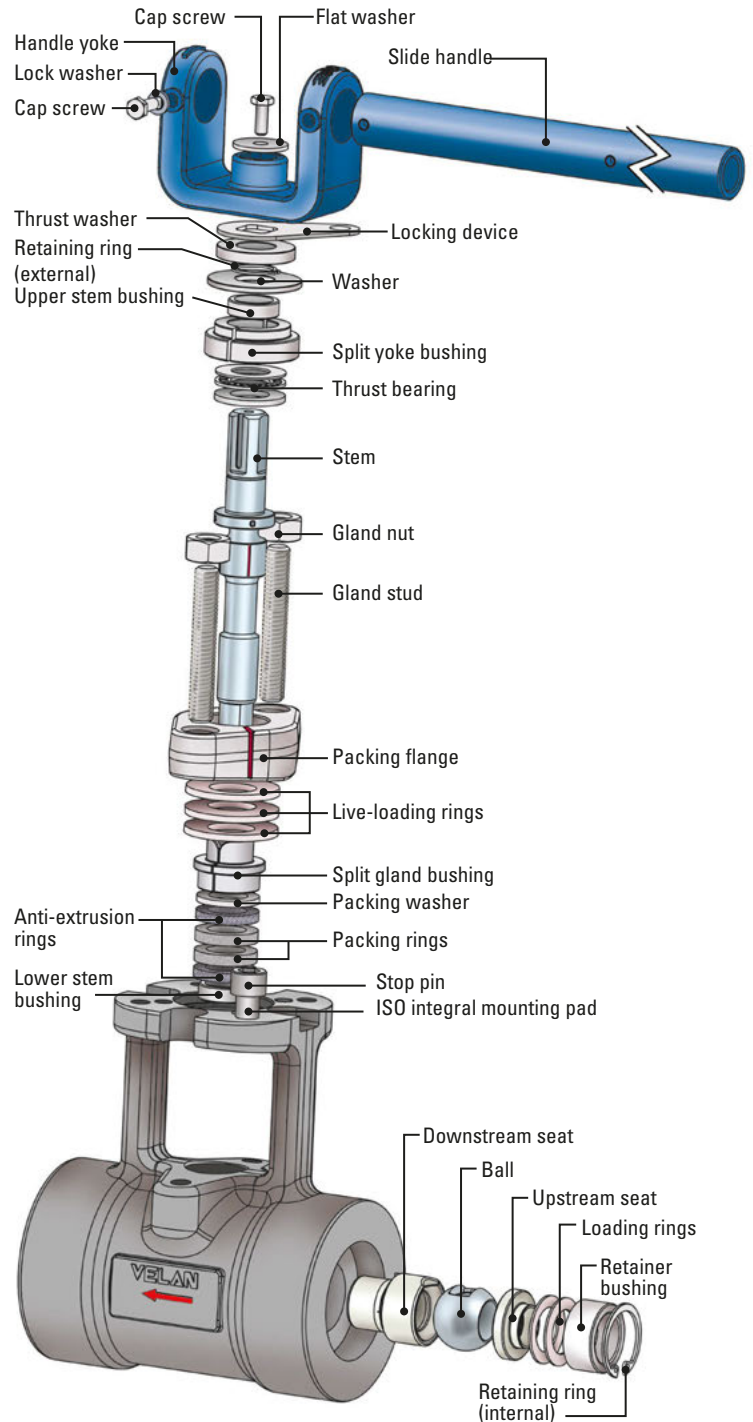



# STANDARD DIMENSIONS

## STANDARD DIMENSIONS OF REGULAR PORT, Cv FLOW COEFFICIENT, AND WEIGHTS

Size NPS (DN)	Class	ØE in (mm)	A in (mm)				B	C	D	ØF	G	H	J	L	M	ØN	P	Weight	
			SW	BW	BW <sub>N</sub>													in (mm)	
1/2 (15)	3100								0.87 (22)	0.38 (10)									
1/2 (15)	4500	0.44 (11)	5.00 (127)	-	6.50 (165)	6.74 (171)	12 (305)	2.50 (64)			4.53 (115)	4.00 (102)	-	-	-	-	9 (8)	12.8 <sup>(1)</sup> (5.8)	
3/4 (20)	3100								1.08 (27)	0.50 (13)									
3/4 (20)	4500		5.00 (127)																
1 (25)	3100	0.63 (16)	5.25 (133)	-	6.50 (165)	6.74 (171)	12 (305)	2.63 (67)	1.34 (34)	0.50 (13)	4.53 (115)	3.87 (98)	-	-	-	-	10 (9)	16.6 <sup>(1)</sup> (7.5)	
1 (25)	4500			-	6.50 (165)				1.34 (34)			3.87 (98)							
1 1/4 (32)	3100	0.63 (16)	5.25 (133)	5.25 (133)	6.75 (171)	6.74 (171)	12 (305)	2.63 (67)	1.69 (43)	0.50 (13)	4.53 (115)	4.12 (105)	-	-	-	-	10 (9)	16.6 <sup>(1)</sup> (7.5)	
1 1/4 (32)	4500																		
1 1/2 (40)	3100			7.50 (191)					1.93 (49)	0.50 (13)									
1 1/2 (40)	4500	1.06 (27)	7.50 (191)	-	9.50 (241)	10.72 (272)	26.25 (667)	3.75 (95)			7.76 (197)	5.75 (146)	-	-	-	-	35 (30)	55.3 <sup>(1)</sup> (25.1)	
2 (50)	3100			7.50 (191)					2.42 (61)	0.62 (16)									
2 (50)	4500																		
2 1/2 (65)	3100			10.00 (254)	-				2.92 (74)	0.62 (16)									
2 1/2 (65)	4500					12.50 (318)						7.50 (191)							
3 (80)	3100	1.50 (38)						5.00 (127)			10.00 (254)		13.43 (341)	11.50 (292)	24.00 (610)	11.75 (298)	85 (72)	154.3 <sup>(2)</sup> (70.0)	
3 (80)	4500		10.00 (254)																
4 (100)	3100																		
4 (100)	4500																		

BW<sub>N</sub> = Butt weld end with nipple. (1) c/w Handle weight. (2) c/w Gear actuator weight

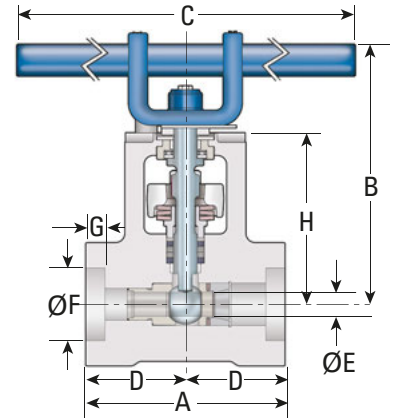

Valve with slide handle

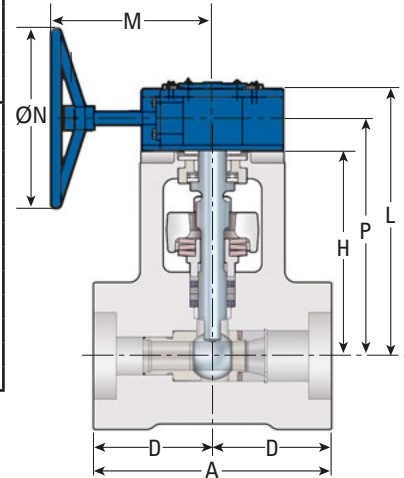

Valve with gear box  
for NPS 2 1/2-4 (DN 65-100) valves

## STANDARD DIMENSIONS OF FULL PORT, Cv FLOW COEFFICIENT, AND WEIGHTS

Size NPS (DN)	Class	ØE in (mm)	A in (mm)				B	C	D	ØF	G	H	J	L	M	ØN	P	Weight	
			SW	SW <sub>N</sub>	BW	BW <sub>N</sub>												in (mm)	
1/2 (15)	3100								0.87 (22)	0.38 (10)	4.53 (115)	4.00 (102)	-	-	-	-	9 (8)	12.8 <sup>(1)</sup> (5.8)	
1/2 (15)	4500	0.44 (11)	5.00 (127)	-	6.50 (165)	6.74 (171)	10.60 (269)	2.50 (64)	0.87 (22)	0.38 (10)	4.53 (115)	4.00 (102)	-	-	-	-	9 (8)	12.8 <sup>(1)</sup> (5.8)	
3/4 (20)	3100								1.08 (27)	0.50 (13)	4.53 (115)	4.12 (105)	-	-	-	-	10 (9)	16.6 <sup>(1)</sup> (7.5)	
3/4 (20)	4500	0.63 (16)	-	6.75 (171)	-	6.74 (171)	10.60 (269)	2.63 (67)	1.08 (27)	0.50 (13)	4.53 (115)	4.12 (105)	-	-	-	-	10 (9)	16.6 <sup>(1)</sup> (7.5)	
1 (25)	3100																		
1 (25)	4500			9.50 (241)															
1 1/4 (32)	3100	1.06 (27)				10.72 (272)	24.10 (612)	3.75 (95)	1.93 (49)	0.50 (13)	7.76 (197)	5.75 (146)	-	-	-	-	35 (30)	55.3 <sup>(1)</sup> (25.1)	
1 1/4 (32)	4500																		
1 1/2 (40)	3100		7.50 (191)		9.50 (241)														
1 1/2 (40)	4500																		
2 (50)	3100	1.50 (38)		12.50 (318)				5.00 (127)	2.42 (61)	0.62 (16)	10.00 (254)	7.50 (191)	13.43 (341)	11.50 (292)	24.00 (610)	11.75 (298)	85 (72)	154.3 <sup>(2)</sup> (70.0)	
2 (50)	4500																		

BW<sub>N</sub> = Butt weld end with nipple. (1) c/w Handle weight. (2) c/w Gear actuator weight

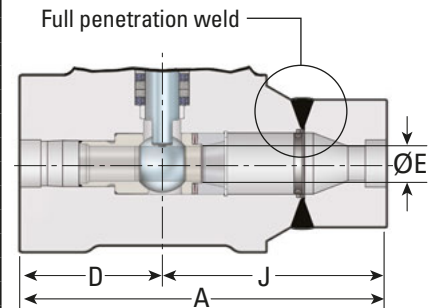

Valve with nipple

# STANDARD DIMENSIONS

## DIMENSIONS FOR BUTT WELD END CONFORMING TO REQUIREMENTS OF ASME B16.25 AND B36.10

NPS (DN)	Pipe sch. number	Butt weld w/nipple		ØW	ØX	Y	Z	Wall Thickness	Bore size <sup>(1)</sup>	
		3100	4500							
in (mm)										
½ (15)	80	✓	✓	0.840 (21.3)	0.546 (13.87)	0.22 (5.59)	0.29 (7.37)	0.147 (3.73)	0.63 (16)	
	160				0.464 (11.79)	0.28 (7.11)	0.38 (9.65)	0.188 (4.78)	0.44 (11)	
	XXS				0.252 (6.40)	0.44 (11.18)	0.59 (14.99)	0.294 (7.47)	0.44 (11)	
¾ (20)	80	✓	✓	1.050 (26.7)	0.742 (18.85)	0.23 (5.84)	0.31 (7.87)	0.154 (3.91)	1.06 (27)	
	160				0.612 (15.55)	0.33 (8.38)	0.44 (11.18)	0.219 (5.56)	0.63 (16)	
	XXS				0.434 (11.02)	0.46 (11.68)	0.62 (15.75)	0.308 (7.82)	0.44 (11)	
1 (25)	80	✓	✓	1.315 (33.4)	0.957 (24.31)	0.27 (6.86)	0.36 (9.14)	0.179 (4.55)	1.06 (27)	
	160				0.815 (20.70)	0.38 (9.65)	0.50 (12.70)	0.250 (6.35)	1.06 (27)	
	XXS				0.599 (15.22)	0.54 (13.72)	0.72 (18.29)	0.358 (9.09)	0.63 (16)	
1¼ (32)	80	-	-	1.660 (42.2)	1.278 (32.46)	0.29 (7.37)	0.38 (9.65)	0.191 (4.85)	1.50 (38)	
	160	-	-		1.160 (29.46)	0.38 (9.65)	0.50 (12.70)	0.250 (6.35)	1.50 (38)	
	XXS	✓	✓		0.896 (22.76)	0.57 (14.48)	0.76 (19.30)	0.382 (9.70)	1.06 (27)	
1½ (40)	80	-	-	1.900 (48.3)	1.500 (38.10)	0.30 (7.62)	0.40 (10.16)	0.200 (5.08)	1.50 (38)	
	160	-	-		1.337 (33.96)	0.42 (10.67)	0.56 (14.22)	0.281 (7.14)	1.50 (38)	
	XXS	✓	✓		1.100 (27.94)	0.60 (15.24)	0.80 (20.32)	0.400 (10.16)	1.06 (27)	
2 (50)	80	-	-	2.375 (60.3)	1.939 (49.25)	0.33 (8.38)	0.44 (11.18)	0.218 (5.54)	2.00 (51)	
	160	-	-		1.687 (42.85)	0.52 (13.21)	0.69 (17.53)	0.344 (8.74)	2.00 (51)	
	XXS	✓	✓		1.503 (38.18)	0.65 (16.51)	0.87 (22.10)	0.436 (11.07)	1.50 (38)	
2½ (65)	80	-	-	2.875 (73.0)	2.323 (59.00)	0.41 (10.41)	0.55 (13.97)	0.276 (7.01)	2.50 (64)	
	160	-	-		2.125 (53.98)	0.56 (14.22)	0.75 (19.05)	0.375 (9.53)	2.00 (51)	
	XXS	✓	✓		1.771 (44.98)	0.83 (21.08)	1.10 (27.94)	0.552 (14.02)	2.00 (51)	
3 (80)	80	-	-	3.500 (88.9)	2.900 (73.66)	0.45 (11.43)	0.60 (15.24)	0.300 (7.62)	3.00 (76)	
	160	-	-		2.624 (66.65)	0.66 (16.76)	0.88 (22.35)	0.438 (11.13)	2.50 (64)	
	XXS	✓	✓		2.300 (58.42)	0.90 (22.86)	1.20 (30.48)	0.600 (15.24)	2.50 (64)	
4 (100)	80	-	-	4.500 (114.3)	3.826 (97.18)	0.51 (12.95)	0.67 (17.02)	0.337 (8.56)	3.50 (89)	
	160	-	-		3.438 (87.33)	0.80 (20.32)	1.06 (26.92)	0.531 (13.49)	3.50 (89)	
	XXS	✓	✓		3.152 (80.06)	1.01 (25.65)	1.35 (34.29)	0.674 (17.12)	3.00 (76)	

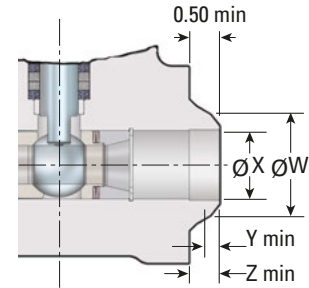

Butt weld end

**NOTE:** If specifying a butt weld end valve, please refer to "Dimensions for butt weld end" table (left) to determine if the valve is available with an integral butt weld or a nipple on one end.

For standard dimension "A" (see tables on page 9) use column "BW" when specifying valves with an integral butt weld, and column "BW<sub>N</sub>" when specifying valves with a nipple.

For any special requirements, please consult the factory.

(1) Recommended minimum valve bore size as per ASME TPD-1. Minimum 85% of the cross-sectional area of the connecting pipe. For bore size larger than 1.50, please refer to our R-Type valve in the Securaseal catalogue.

## VELAN POWER BALL VALVES READY FOR SERVICE



Flanged Power Ball for easy installation.



Stub end welded Power Ball valves in production.

# END CONNECTION TABLE

## NIPPLE REQUIREMENT

TYPE	Bore size in (mm) >		0.44 (11)		0.63 (16)		1.06 (27)		1.50 (38)	
	Max. Pressure Class >		3100	4500	3100	4500	3100	4500	3100	4500
	NPS	SCH.								
BUTT WELD	0.5	80	N	N	N	N	-	-	-	-
		160	N	N	-	-	-	-	-	-
		XXS	N	N	-	-	-	-	-	-
	0.75	80	N	N	N	N	-	-	-	-
		160	N	N	N	N	-	-	-	-
		XXS	N	N	-	-	-	-	-	-
	1	80	X	X	N	N	N	N	-	-
		160	X	X	N	N	N	N	-	-
		XXS	N	N	N	N	-	-	-	-
	1.25	80	X	-	X	X	N	N	-	-
		160	X	-	X	X	N	N	-	-
		XXS	X	X	N	N	N	N	-	-
	1.5	80	-	-	X	-	N	N	N	N
		160	X	-	X	X	N	N	N	N
		XXS	X	-	N	N	N	N	-	-
	2	80	-	-	-	-	X	X	N	N
		160	-	-	X	-	N	N	N	N
		XXS	-	-	X	-	N	N	N	N
2.5	80	-	-	-	-	X	-	N	N	
	160	-	-	-	-	X	-	N	N	
	XXS	-	-	X	-	N	N	N	N	
3	80	-	-	-	-	-	-	X	X	
	160	-	-	-	-	-	-	N	N	
	XXS	-	-	-	-	X	-	N	N	
4	80	-	-	-	-	-	-	-	-	
	160	-	-	-	-	-	-	X	-	
	XXS	-	-	-	-	-	-	X	-	
SOCKET WELD	0.25	ALL	N	N	N	N	-	-	-	-
	0.375		N	N	N	N	-	-	-	-
	0.5		X	X	N	N	N	N	-	-
	0.75		X	X	N	N	N	N	-	-
	1		X	-	X	X	N	N	N	N
	1.25		-	-	X	-	N	N	N	N
	1.5		-	-	X	-	X	X	N	N
2	-	-	-	-	X	X	N	N		
2.5	-	-	-	-	-	-	X	X		
NPT	0.375	ALL	N	N	N	N	-	-	-	-
	0.5		N	N	N	N	-	-	-	-
	0.75		X	X	N	N	N	N	-	-
	1		X	X	X	X	N	N	-	-
	1.25		-	-	X	X	N	N	N	N
	1.5		-	-	X	-	N	N	N	N
	2		-	-	-	-	X	X	N	N
2.5	-	-	-	-	-	-	N	N		

- X = Integral
- N = Nipple required
- = Not available

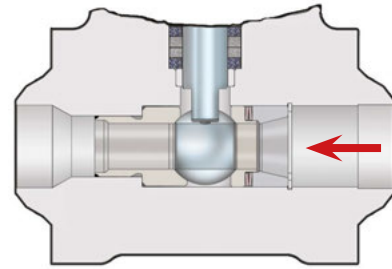

**Butt weld end**

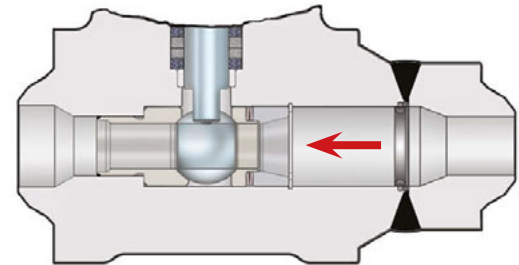

**Butt weld end with nipple**

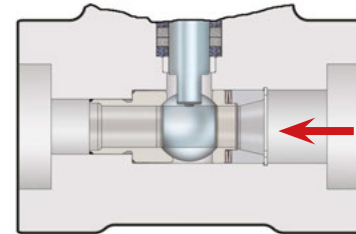

**Socket weld end**

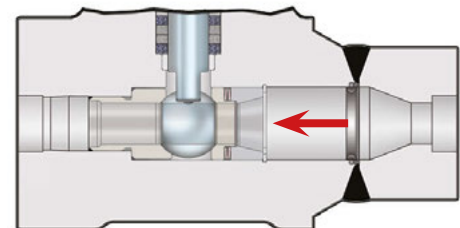

**Socket weld end with nipple**

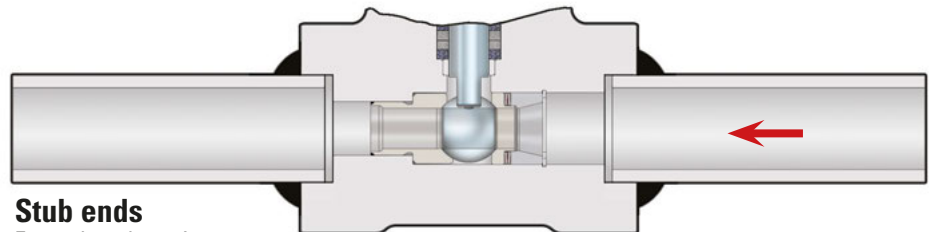

**Stub ends**

For stub end requirements contact Velan.



# PRESSURE-TEMPERATURE RATINGS

## FORGED CARBON STEEL A105

Working Pressure, psig

CLASS Temp. °F	3100			4500		
	Standard	Special <sup>(2)</sup>	Limited <sup>(3)</sup>	Standard	Special <sup>(2)</sup>	Limited <sup>(3)</sup>
-20 to 100	7652	7750	7750	11110	11250	11250
200	7014	7750	7750	10120	11250	11250
300	6760	7651	7651	9845	11250	11250
400	6548	7572	7572	9505	11250	11250
500	6230	7572	7572	8980	11250	11250
600	5866	7572	7572	8210	10690	10690
650	5675	7391	7391	8055	10485	10485
700	5486	7142	7142	7990	10405	10405
750	5244	6554	6554	7560	9450	9450
800	4252	5314	5314	6170	7715	7715
850 <sup>(1)</sup>	3294	4118	4118	4010	5015	5015

## FORGED CHROME-MOLY STEEL A182-F22 CL. 3

Working Pressure, psig

CLASS Temp. °F	3100			4500		
	Standard	Special <sup>(2)</sup>	Limited <sup>(3)</sup>	Standard	Special <sup>(2)</sup>	Limited <sup>(3)</sup>
-20 to 100	7750	7750	7750	11250	11250	11250
200	7750	7750	7750	11250	11250	11250
300	7527	7639	7639	10925	11120	11120
400	7292	7520	7520	10585	10865	10865
500	6868	7484	7484	9965	10800	10800
600	6249	7452	7452	9070	10800	10800
650	6081	7396	7396	8825	10735	10735
700	5866	7308	7308	8515	10670	10670
750	5492	7308	7308	7970	10350	10350
800	5244	7308	7308	7610	10095	10095
850	5034	7000	7000	7305	9645	9645
900	4644	6200	6200	6740	9000	9000 <sup>(4)</sup>
950	3993	4872	5098	5665	7070	7555 <sup>(4)</sup>
1000	2764	3454	3983	3910	4885	6050 <sup>(4)</sup>
1050	1806	2258	2604	2625	3280	4060
1100	1134	1418	1635	1645	2055	2546

## FORGED CHROME-MOLY STEEL A182-F91

Working Pressure, psig

CLASS Temp. °F	3100			4500		
	Standard	Special <sup>(2)</sup>	Limited <sup>(3)</sup>	Standard	Special <sup>(2)</sup>	Limited <sup>(3)</sup>
-20 to 100	7750	7750	7750	11250	11250	11250
200	7750	7750	7750	11250	11250	11250
300	7527	7750	7750	10925	11250	11250
400	7292	7750	7750	10585	11250	11250
500	6868	7750	7750	9965	11250	11250
600	6249	7750	7750	9070	11250	11250
650	6081	7750	7750	8825	11250	11250
700	5866	7576	7576	8515	10995	10995
750	5492	7528	7528	7970	10930	10930
800	5244	7440	7440	7610	10800	10800
850	5034	7000	7000	7305	10160	10160
900	4644	6200	6200	6740	9000	9000
950	3993	4872	5098	5795	7070	7555
1000	3756	4347	5012	5450	6310	7555
1050	3720	4347	5012	5400	6310	7555
1100	3118	3898	4495	4525	5655	7005
1150	2302	2878	3319	3345	4180	5175
1200	1488	1860	2145	2160	2700	3345

## FORGED STAINLESS STEEL A182 Gr. F316

Working Pressure, psig

CLASS Temp. °F	3100			4500		
	Standard	Special <sup>(2)</sup>	Limited <sup>(3)</sup>	Standard	Special <sup>(2)</sup>	Limited <sup>(3)</sup>
-20-100	7440	7750	7750	10800	11250	11250
200	6399	7142	7142	9290	10350	10350
300	5779	6448	6448	8390	9360	9360
400	5308	5923	5923	7705	8550	8550
500	4936	5507	5507	7165	7970	7970
600	4663	5203	5203	6770	7555	7555
650	4564	5092	5092	6660	7395	7395
700	4489	5009	5009	6515	7265	7265
750	4415	4928	4928	6410	7135	7135
800	4365	4872	4872	6335	7070	7070
850	4316	4817	4817	6265	6990	6990
900	4291	4787	4787	6230	6945	6945
950	3993	4732	4732	5795	6870	6870
1000	3756	4347	4347	5245	6310	6310
1050 <sup>(5)</sup>	3720	4347	4347	5155	6310	6310 <sup>(4)</sup>
1100 <sup>(5)</sup>	3154	3942	4125	4575	5720	6110 <sup>(4)</sup>
1150 <sup>(5)</sup>	2444	3056	3524	3550	4435	5495 <sup>(4)</sup>
1200 <sup>(5)</sup>	1914	2392	2758	2775	3470	4300
1250 <sup>(5)</sup>	1524	1904	2196	2210	2765	3425

(1) Permissible but not recommended for prolonged usage above 800°F (425°C).

(2) Special Class: requires additional inspection per ASME B16.34, para. 2.1.2.

(3) Limited Class: only up to and including NPS 2½ (DN 65) socket weld all classes. Flanged valves are not allowed.

(4) Do not interpolate between these temperatures. Consult the factory.

(5) At temperatures over 1000°F (538°C) use only when the carbon content is 0.04% or higher (material code 10).

# TORQUE VALUES FOR CLASSES 3100 – 4500

SIZE NPS (DN)	CLASS	FIGURE NUMBER	LENGTH	AT SATURATED STEAM 662°F (350°C)			AT SUPERHEATED STEAM 1000°F (538°C)			C/W 1.5 SAFETY FACTOR AT SUPERHEATED STEAM	
				DESIGN PRESSURE	TORQUE MAX	HANDLE FORCE	DESIGN PRESSURE	TORQUE MAX	HANDLE FORCE	TORQUE MAX	HANDLE FORCE
				in (mm)	psig (bar)	lbf-in (Nm)	lbf (N)	psig (bar)	lbf-in	lbf (N)	lbf-in (Nm)
½ – ¾ (15–20)	3100	W03-C2Q	10.5 (267)	2611 (180)	227 (26)	22 (98)	1470 (120)	209 (24)	20 (89)	313 (36)	30 (133)
	4500	W03-52Q					2430 (168)	224 (25)	21 (93)	336 (38)	32 (142)
1–1¼ (25–32)	3100	W05-C2Q	10.5 (267)	2611 (180)	305 (35)	29 (129)	1470 (120)	252 (29)	24 (107)	378 (43)	36 (160)
	4500	W05-52Q					2430 (168)	297 (34)	28 (125)	446 (50)	42 (187)
1½–2 (40–50)	3100	W08-92Q	24 (610)	2611 (180)	1324 (150)	55 (245)	1470 (120)	1092 (123)	46 (205)	1638 (185)	68 (303)
	4500	W08-52Q					2430 (168)	1287 (145)	54 (240)	1931 (218)	80 (356)
2½ – 4 (65–100)	3100	W09-C2Q	24 (610)	2611 (180)	1324 (150)	55 (245)	1470 (120)	2290 (259)	GEAR	3435 (388)	GEAR
	4500	W09-52Q					2430 (168)	2862 (323)	GEAR	4293 (485)	GEAR
							3910 (270)	3744 (423)	GEAR	5616 (635)	GEAR

# ACTUATORS

## GEAR ACTUATORS

Velan worm gear actuators provide reliable and dependable manual operation for NPS 2½–4 (DN 65–100) regular port and NPS 2 (DN 50) full port Power Ball valves. The gear is designed to operate in the range of 90°, ±5° and is equipped with an angular dial indicator. Worm gear actuators feature a gear segment and a rigid, reversible shaft with integral worm. The gear actuators comply with ISO 5211 and are suitable for high-temperature service.

## AIR AND ELECTRIC ACTUATORS

Velan supplies high-quality pneumatic rack and pinion and scotch yoke actuators for NPS ½–4 (DN 15–100) Power Ball valves. All actuators are totally enclosed. External adjustment stops provide accurate adjustment for closing and opening positions. All moving parts are permanently lubricated. Actuators can be installed in the field, although it is preferable that they be installed and tested in the factory.

### GEAR ACTUATOR

for NPS 2½–4 (DN 65–100) regular port and NPS 2 (DN 50) full port valves



### AIR ACTUATOR



### ELECTRIC ACTUATOR



## MOUNTING PAD AND STEM HEAD DIMENSIONS

### UNIQUE VELAN DIRECT MOUNT ADVANTAGE

The Velan's Power Ball valve design makes actuation easy. Direct mounting for all actuators without costly bracket and stem coupling, which results in less angle play.

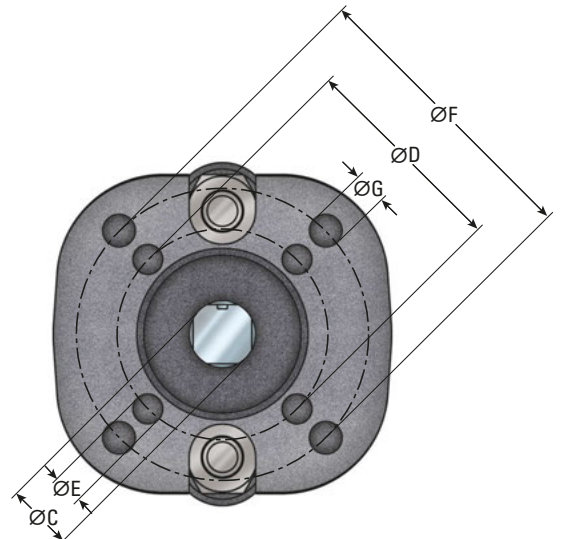
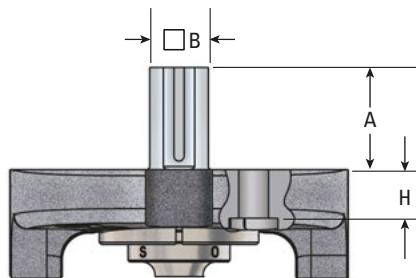
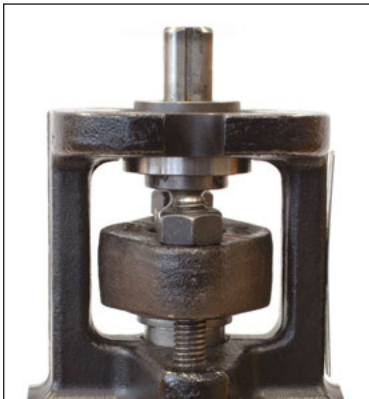

Regular port		Full port		Stem head			Mounting pad 1		Mounting pad 2		H in (mm)	ISO STANDARD
NPS	DN	NPS	DN	A in (mm)	□ B in (mm)	ØC in (mm)	ØD in (mm)	ØE in (mm)	ØF in (mm)	ØG in (mm)		
½ – 1	15 – 25	½ – ¾	15 – 20	.96 (24.4)	.551 (14)	.625 (15.9)	1.984 (50)	9/32 (7.1)	2.750 (70)	21/64 (8.3)	.50 (12.7)	F05/F07
1½ – 2	40 – 50	1–1½	25 – 40	1.07 (27.2)	.866 (22)	1.125 (28.6)	4.000 (102)	27/64 (10.7)	-	-	.72 (18.3)	F10
2½ – 4	65 – 100	2	50	2 (50.8)	1.063 (27)	1.417 (36.0)	4.921 (125)	17/32 (13.5)	-	-	.81 (20.6)	F12

# POWER BALL VALVES IN POWER GENERATION



NPS 1½ (DN 40) Power Ball valves in steam trap isolation at a major British power plant. Switching to Velan's Power Ball valves offered a low torque, easy to operate solution.



A Velan Power Ball valve in service.



A Velan Power Ball valve in high-pressure steam service.

- Attemperator isolation valves
- Boiler feedwater pump recirculation
- Bottom blowdown
- Bypass injector isolation
- Cogeneration (emergency shutdown system)
- Condensate drain lines above/below turbine throttle valves
- Feedwater heater isolation
- Feedwater heater drain
- Feedwater heater loop drain
- Isolation turbine drains
- Low-pressure turbine drains
- Main steam drum vents
- Main steam extraction bleed valves
- Nuclear
- Pressurized fluidized beds (PFB)
- Reheat isolation
- Steam trap isolation
- Seal steam isolation
- Steam (saturated/superheated)
- High-energy isolation valve

## VELAN VALVES FOR THE POWER INDUSTRY

Power Ball valve joins a long list of proven products for power. With an installed base covering over 385 nuclear power plants and over 4,000 thermal power plants and valves with over forty years of uninterrupted nuclear service, Velan is a market leader in power industry valves.

As a matter of fact, most of the valves that Velan designs and manufactures have been sold into power plant applications.



NPS ½–36 (DN 15–900)  
ASME class: 150–4500













### A complete range of large metal-seated ball valves

Velan's Securseal® metal-seated ball valve product group offers the widest range of sealing technology in the industry to meet your severe service requirements, both technically as well as economically, per application.

Velan's Engineering and R&D can also work hand in hand with end users to develop the best engineered solution for your process.



# HOW TO ORDER

Type of connection	Size of connection	Pressure rating	Port	Type	Body	Trim	Coatings	Special service
<b>A</b>	<b>B</b>	<b>C</b>	<b>D</b>	<b>E</b>	<b>F</b>	<b>G H</b>	<b>I</b>	<b>J</b>
	 				 	 		
<b>W</b>	<b>0 5</b>	<b>— C</b>	<b>2</b>	<b>Q</b>	<b>0 2</b>	<b>— A G</b>	<b>S</b>	<b>A</b>

Example: Example: socket weld; NPS 1 (DN 25); class 3100; regular port; one-piece power ball; A105 body; S/S 410 ball, seat and stem; HVOF chrome carbide coating; and standard service

<b>A TYPE OF CONNECTION</b>			
<b>B</b>	Butt weld	<b>S</b>	Thread NPT
<b>C</b>	Combination (socket weld/threaded)	<b>W</b>	Socket weld
<b>E</b>	Welded stubs (butt weld)	<b>Y</b>	Blank ends
<b>F</b>	Flanged B16.5 (B16.47 series A)	<b>Z</b>	Welded stubs socket weld ends

<b>B SIZE OF CONNECTION</b>			
Customers have the choice of specifying valve size as part of the valve figure number ( <b>B</b> ) using the numbers below, or indicating valve size separately. Sizes shown in NPS (DN)			
<b>EXAMPLES:</b> NPS1-W-C1Q02-FRKA (valve size is part of figure number) W05-C1Q02-FRKA (valve size is shown separately)			
<b>03</b>	½ (15)	<b>06</b>	1¼ (32)
<b>04</b>	¾ (20)	<b>07</b>	1½ (40)
<b>05</b>	1 (25)	<b>08</b>	2 (50)
<b>09</b>	2½ (65)	<b>10</b>	3 (80)
<b>12</b>	4 (100)		

<b>C PRESSURE RATING</b>			
<b>C</b>	3100	<b>5</b>	4500

<b>D PORT</b>			
<b>1</b>	Full port	<b>2</b>	Regular port

**Note:** CoCr alloy as used throughout this catalog refers to cobalt chrome hardfacing alloys as supplied by Kennametal Stellite™, and other approved manufacturers.

<b>E TYPE</b>	
<b>Q</b>	Power ball (one-piece)

<b>F BODY MATERIAL</b>			
<b>02</b>	A105	<b>10</b>	F316/316H
<b>06</b>	CHR, MOLY F22	<b>34</b>	F91

<b>G TRIM MATERIAL (ball/seat)</b>			
<b>A</b>	S/S 410	<b>F</b>	Inconel 718

<b>H TRIM MATERIAL (stem)</b>			
<b>G</b>	S/S410	<b>R</b>	S/S 660

<b>I COATING</b>			
<b>K</b>	Spray and fused chrome carbide	<b>S</b>	HVOF chrome carbide

<b>J SPECIAL SERVICE</b>	
<b>A</b>	Standard

**Note:** Velan valves for **NACE** service (as indicated by figure number and/or description) comply with the metallurgical requirements of the current NACE MR0103 and MR0175 / ISO 15156. Material selection is dependent on the actual environment and it is therefore the equipment End User's responsibility to ensure that the materials are suitable for the intended service. Please contact Velan for any questions regarding the application of our products for NACE service.

## Here are other Velan valves proven reliable in applications for the power industry

For more details and product information download catalogs from our website at [www.velan.com](http://www.velan.com). Velan product catalogs can be found under the Resources tab listed in the literature section.



**Pressure seal and bolted bonnet gate, globe, & check valves**  
NPS 2–24 (DN 50–600)  
ASME class: 150–4500



**Forged steel bonnetless y-pattern globe valves**  
NPS ¼–4 (DN 8–100)  
ASME class: 1690–4500



**Universal steam traps**  
NPS ¾–3 (DN 10–80)  
Up to 4000 psi.g



**Torqseal® triple-offset butterfly valves**  
NPS 3–80 (DN 80–2000)  
ASME class: 150–600



**Small forged gate, globe, & check valves**  
NPS ¼–4 (DN 8–100)  
ASME class: 150–4500

*The most comprehensive line of industrial forged and cast steel gate, globe, check, ball, butterfly, and knife gate valves and steam traps.*

**ASME pressure classes 150–4500 in carbon, alloy, and stainless steel**

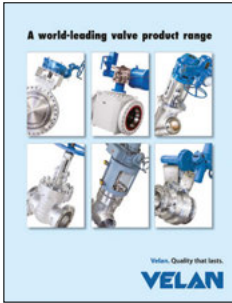

**BRO-FLB**



**SAS-FLB**

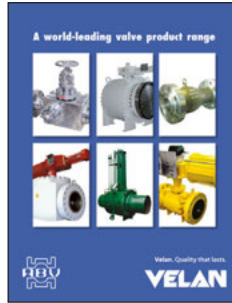

**ABV-FLB**

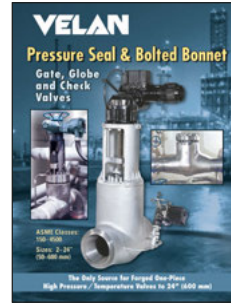

**VEL-PS**

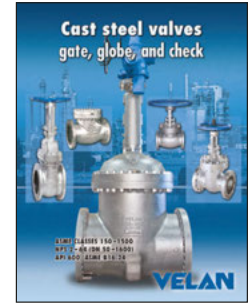

**CAT-CSV**

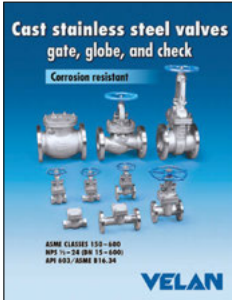

**CAT-CSSV**

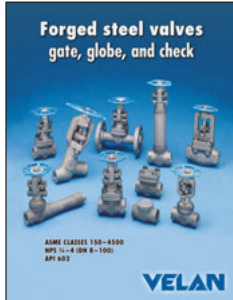

**CAT-SFV**

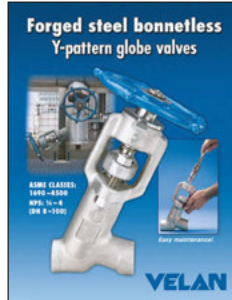

**CAT-BG**

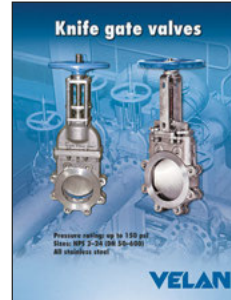

**CAT-KGV**

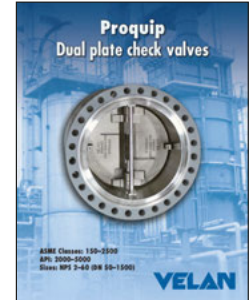

**CAT-DPCV**

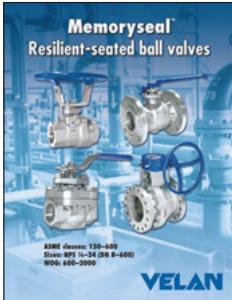

**CAT-BV**

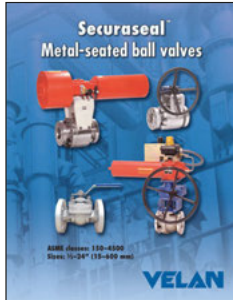

**VEL-MS**

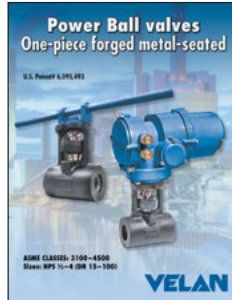

**CAT-PBV**



**BRO-CBV**

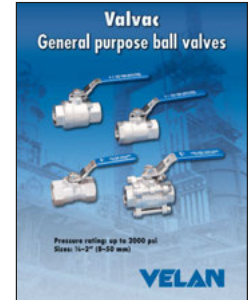

**CAT-GPBV**

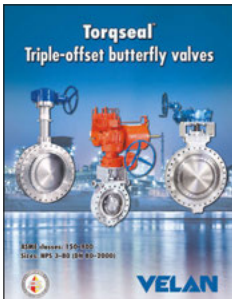

**CAT-BF**



**SAS-CCV**

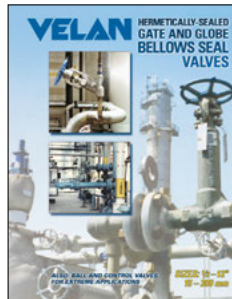

**VEL-BS**

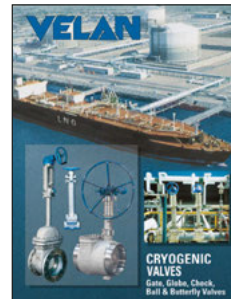

**VEL-CRYO**

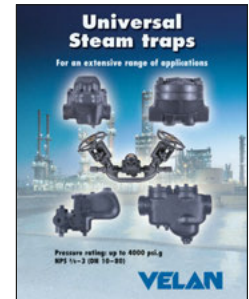

**CAT-ST**

Headquartered in Montreal, Canada, Velan has several international subsidiaries. For general inquiries:

**Velan head office**  
7007 Côte de Liesse, Montreal, QC H4T 1G2 Canada  
Tel: +1 514 748 7743 Fax: +1 514 748 8635

Check our website for more specific contact information.  
[www.velan.com](http://www.velan.com)

**CAT-PBV-03-15a**

Printed in Canada

© 2017 Velan Inc., Montreal, QC, Canada. All rights reserved. The contents hereof are confidential and proprietary to Velan. Any unauthorized reproduction or disclosure, in whole or in part, is strictly prohibited. The material in this catalog is for general information only and shall not be used for specific performance data and material selection without first consulting Velan. Velan reserves the right to change this information without notice. Velan does not accept any liability or damages arising from the use of information in this catalog. Velan, Velan Ultraflex, Steamless, Moss, Torqseal, Memoryseal, Securaseal, Velflex, Rama, Clama, Adareg, and Rama Clama II are trademarks or registered trademarks of Velan Inc. and/or another Velan company. One or more of these trademarks are registered in certain countries/regions, please contact Velan Inc.'s legal department for further information. All other trademarks and registered trademarks are owned by their respective companies.

